

Varenummer: 0107062

Beskrivelse: Seeger låsering AK 45 DIN 983

Mål

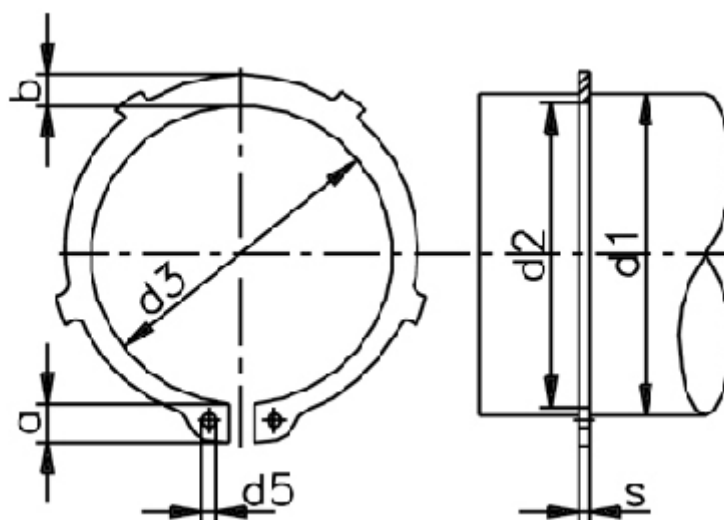

a max	= 7.2	d5 min	= 2.5	Nominal træk	= 3.8
AN mm ²	= 172.0	FN kN	= 28.60	s	= 1.75
Antal takker	= 6	FRg kN	= 9.3	t	= 1.25
b	= 4.6	FR kN	= 49.0	Tang	= ZGA-3
Betegnelse	= AK 45	g	= 2.0	tol	= -0.06
d1	= 45	K kN-mm	= 91.0	tol	= +0,39-0,90
d2	= 42.5	m min	= 1.85	tol	= -0.25
d3	= 41.5	n abl x 1000	= 11	vægt kg/1000	= 8.50